

# BRANCHING PATTERNS PULL REQUEST

María Suárez Hevia UO270437  
Miguel Menéndez Rodríguez UO269871

# RAMAS BÁSICAS

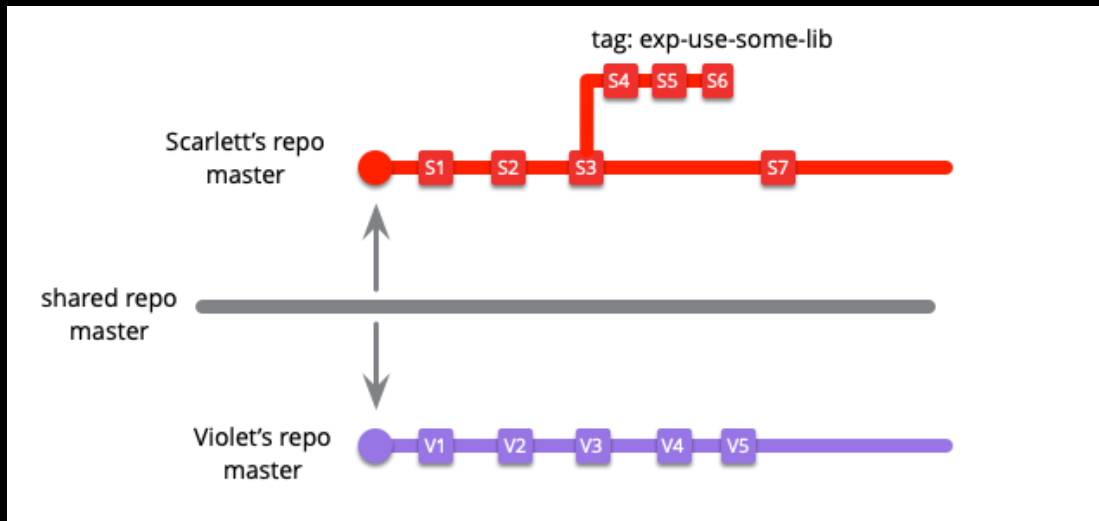

- Source Branching
- MainLine
- Healthy

# BRANCHING PATTERNS



Existen dos categorías principales:

- Patrones de integración: muchos desarrolladores combinan su trabajo en un conjunto coherente.
- Patrones de producción: usar ramas para llegar de un código base a un producto funcionando (en producción).

# PATRONES DE INTEGRACIÓN



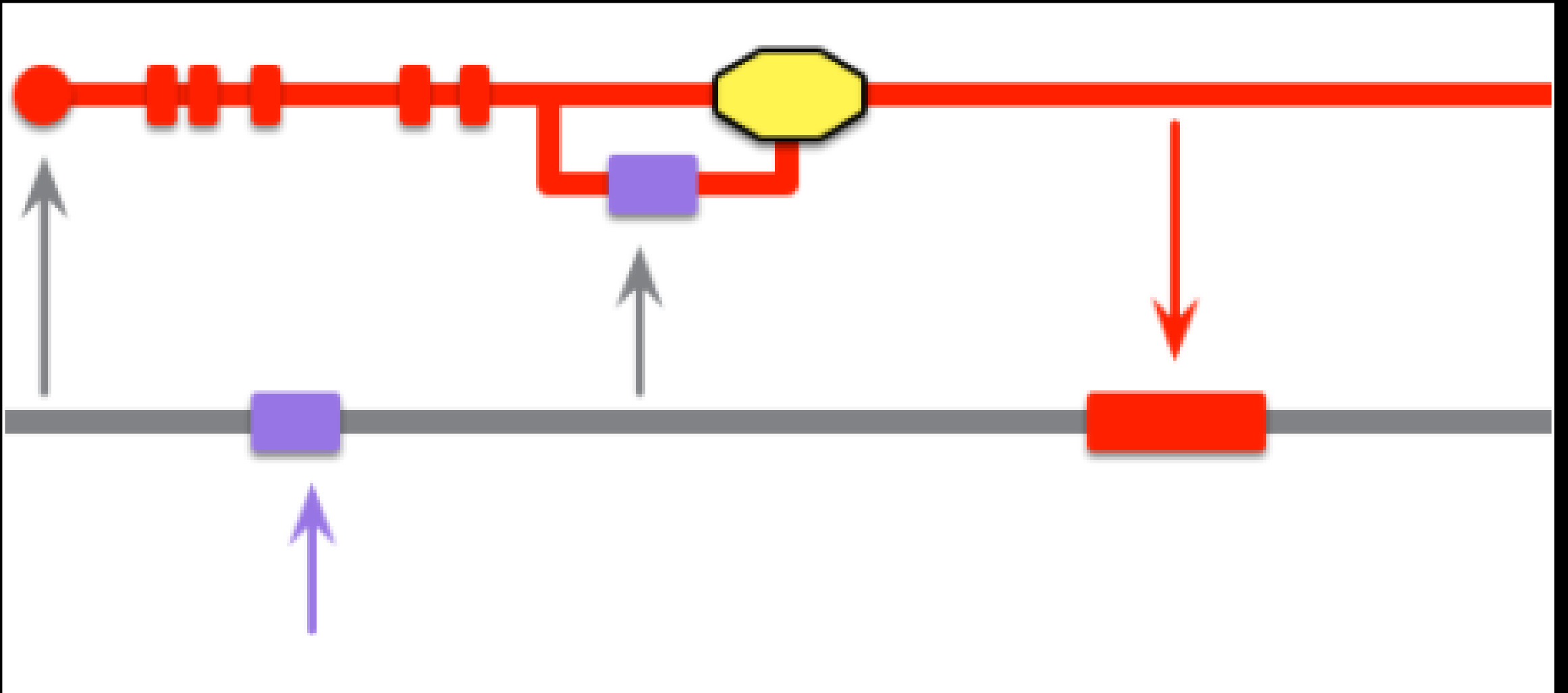

MAINLINE INTEGRATION

Scarlett's repo  
feature branch



Scarlett's repo  
master



shared repo  
master

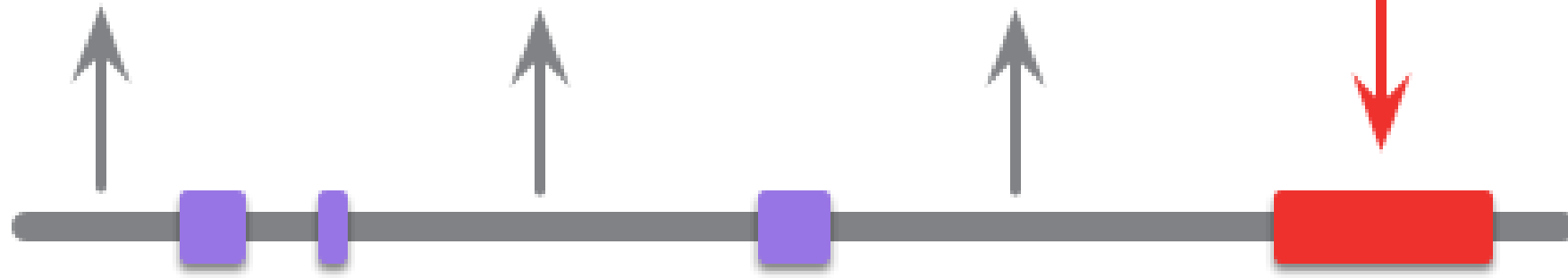

# FEATURE BRANCHING

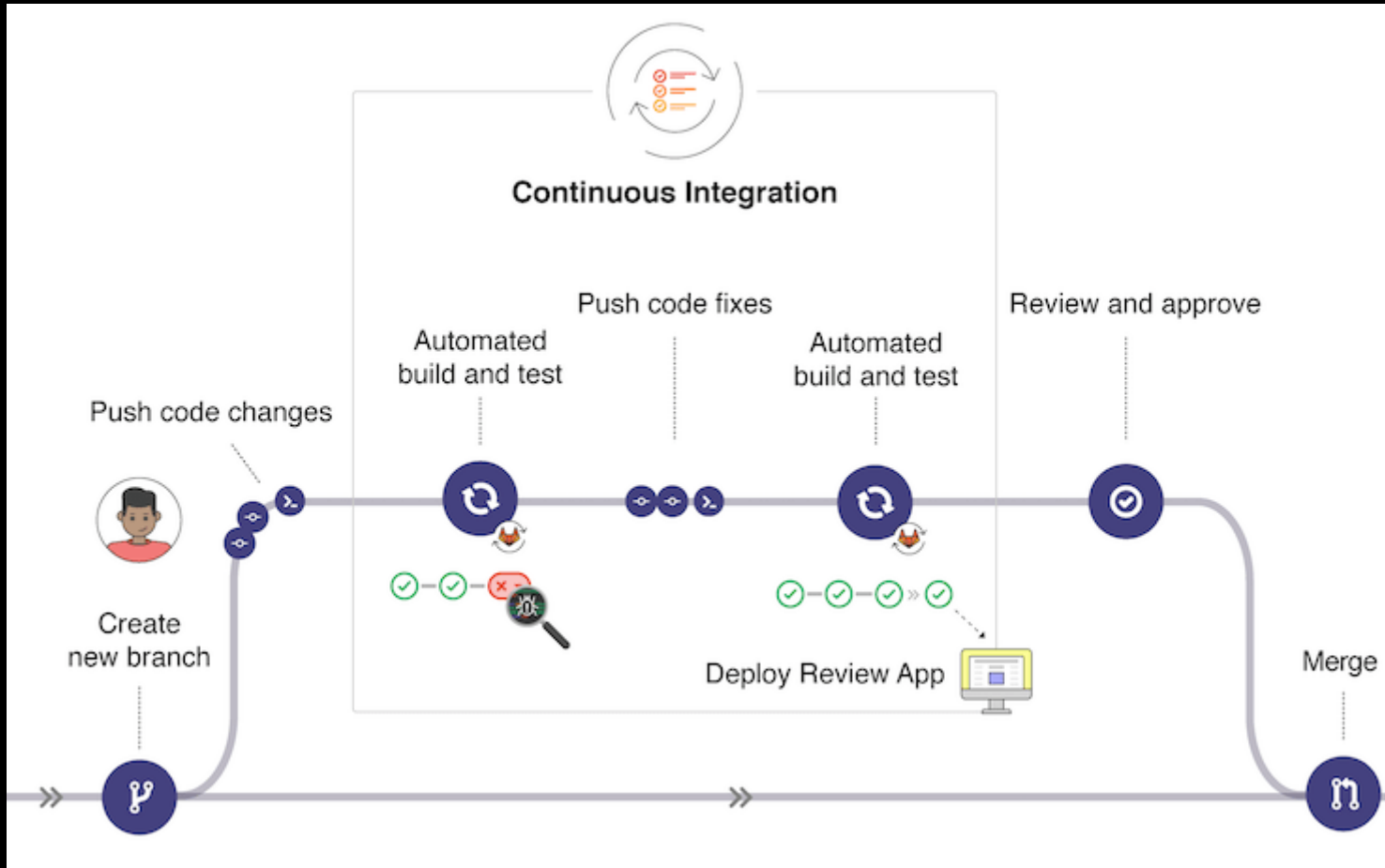

# CONTINUOUS INTEGRATION



**PRE-INTEGRATION REVIEW**



### Low Frequency

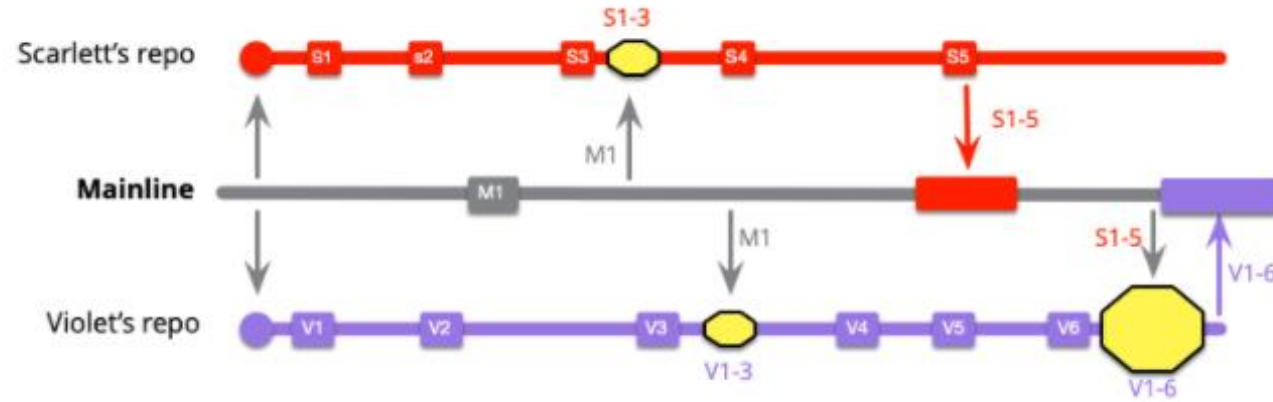

### High Frequency

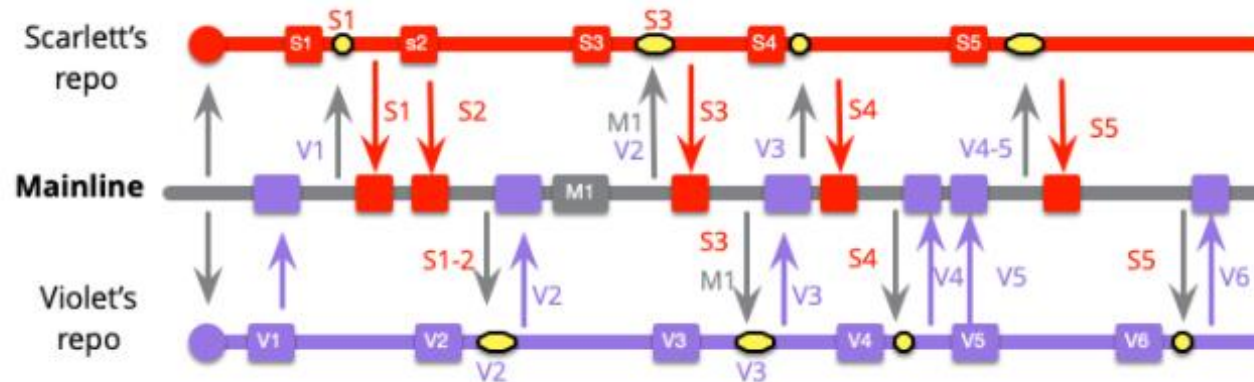

FRECUENCIA DE INTEGRACIÓN

# PATRONES DE PRODUCCIÓN

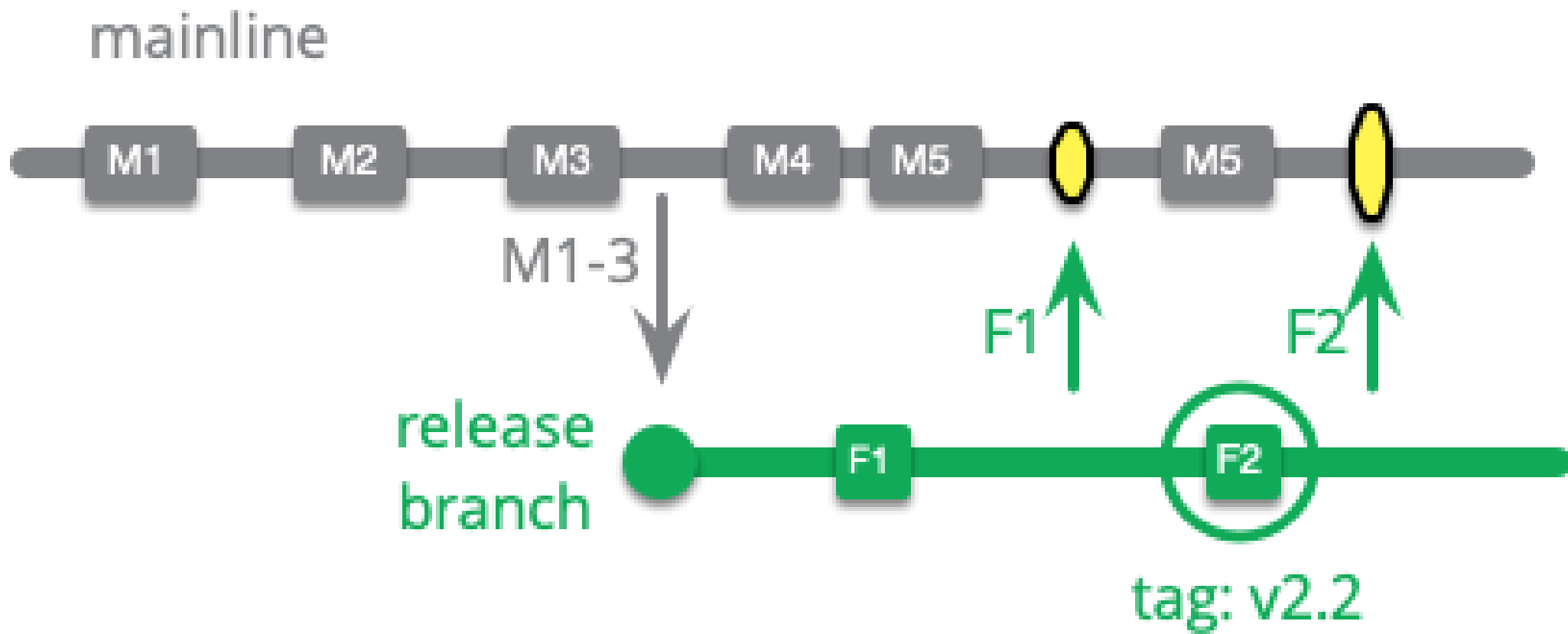

RELEASE BRANCH

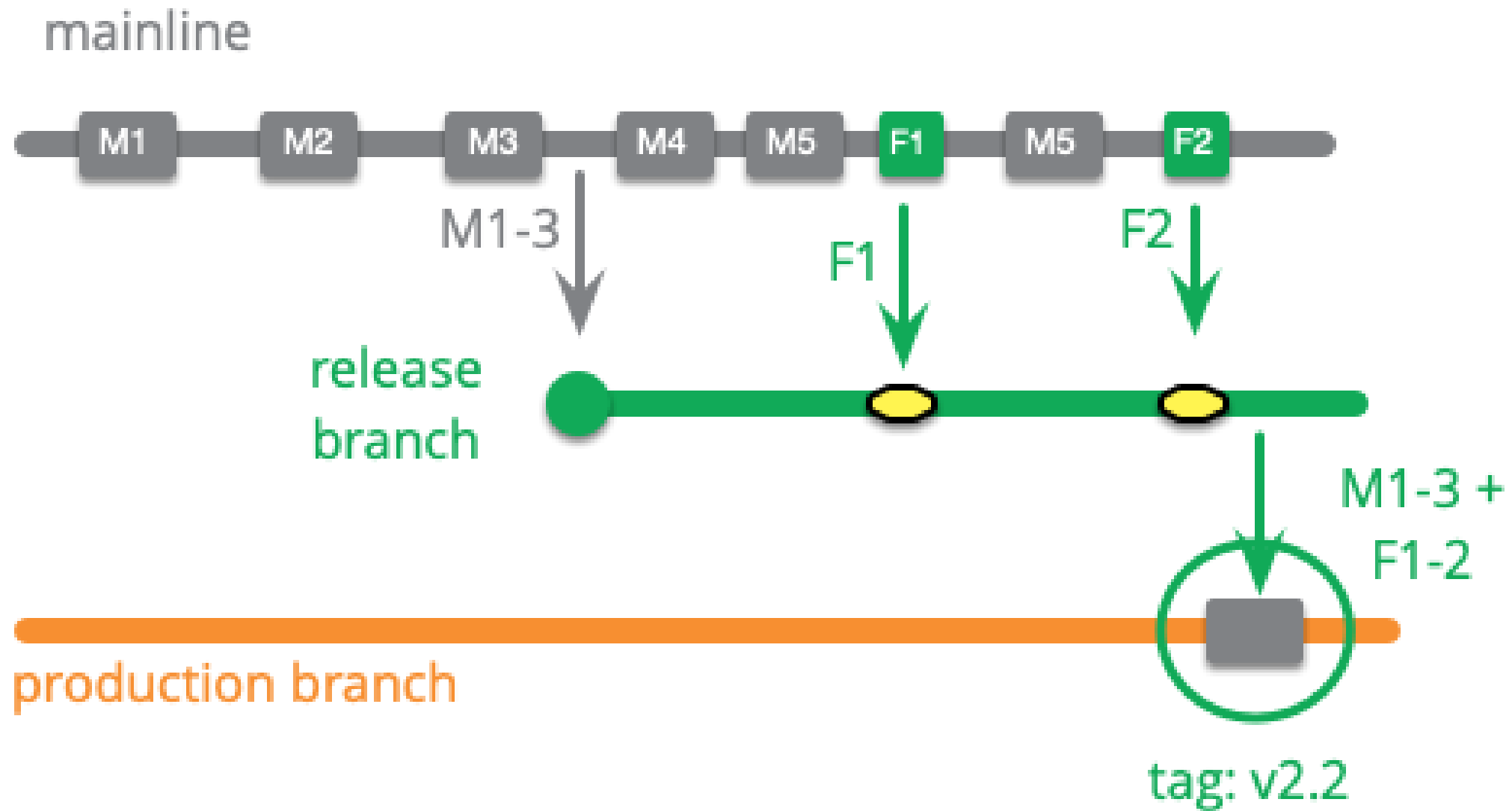

# MATURITY BRANCH

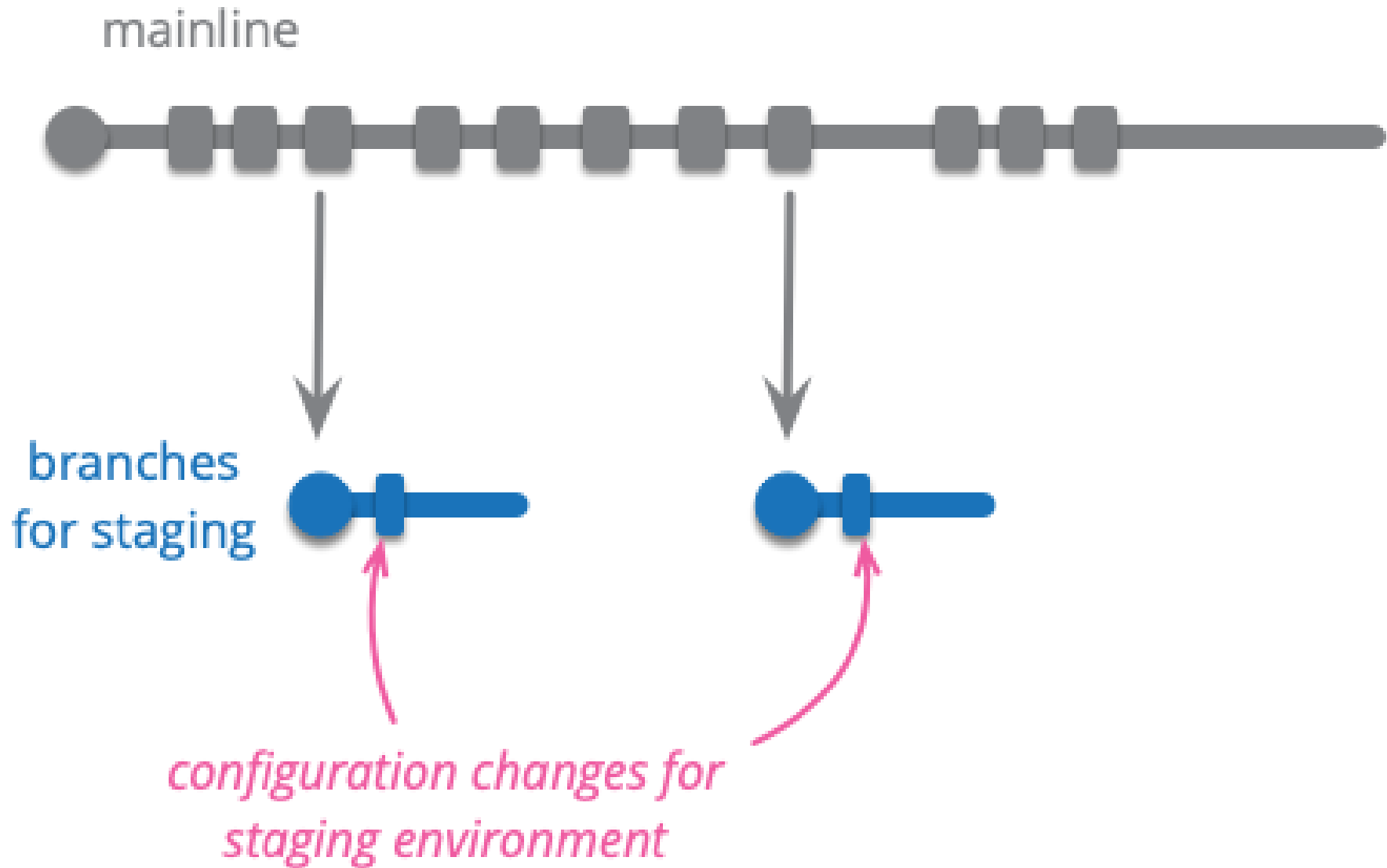

ENVIROMENT BRANCH

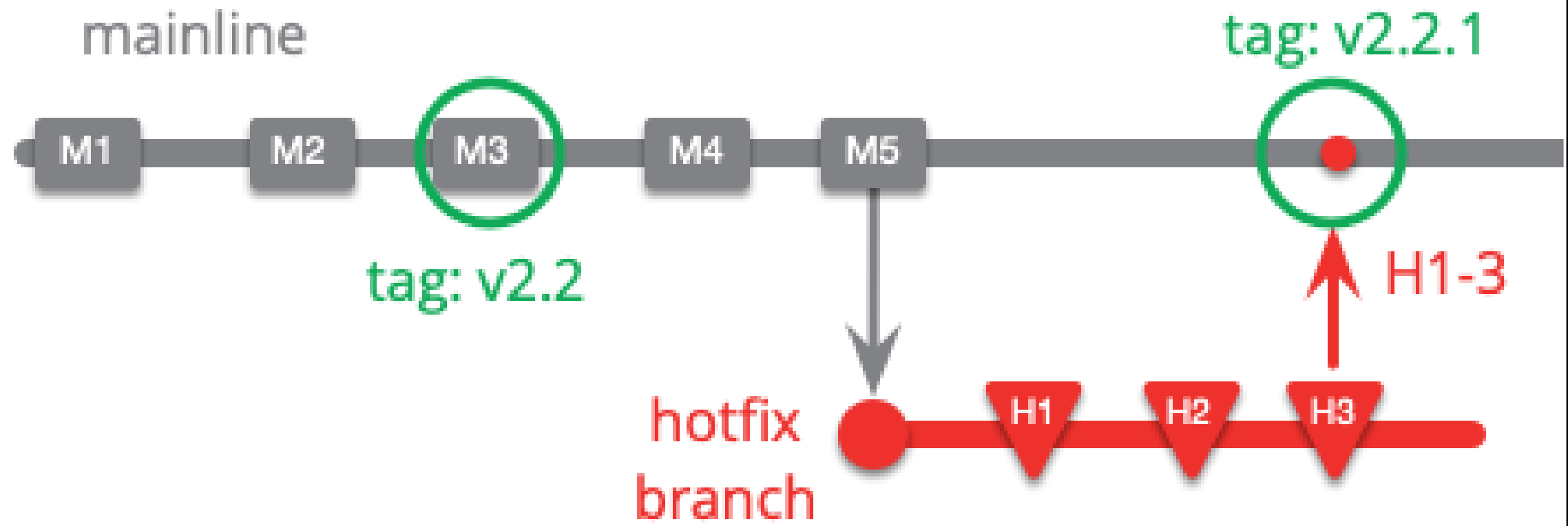

HOTFIX BRANCH

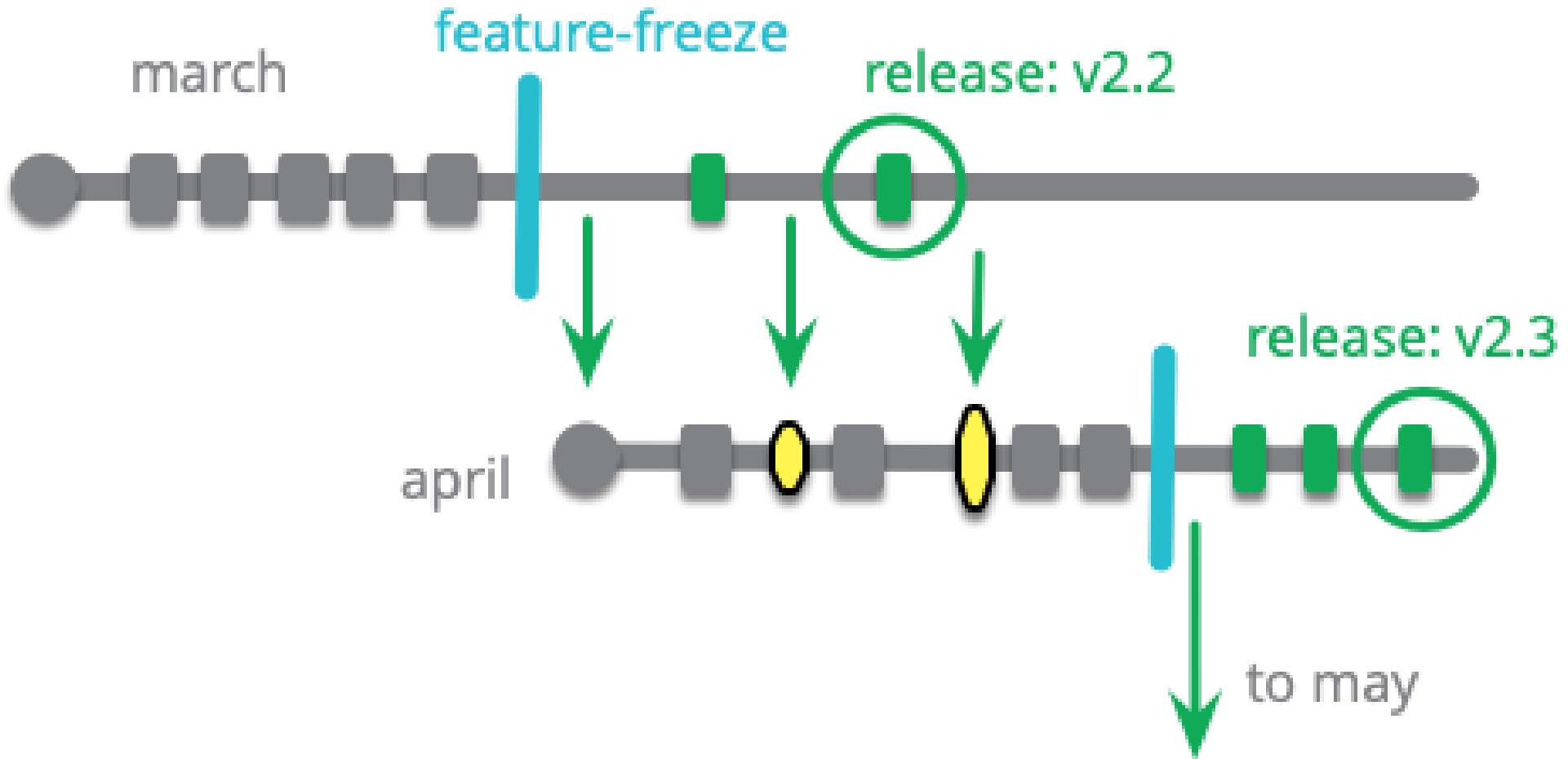

# RELEASE TRAIN

release to  
production

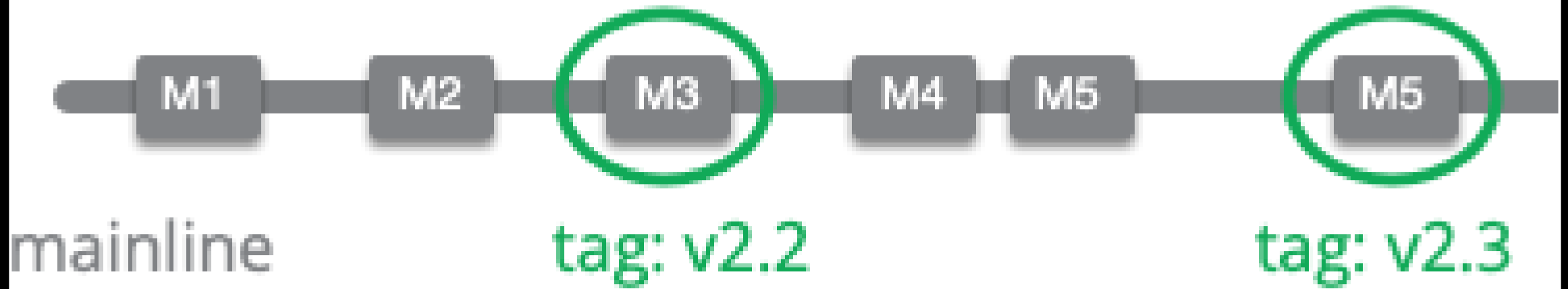

RELEASE-READY MAINLINE



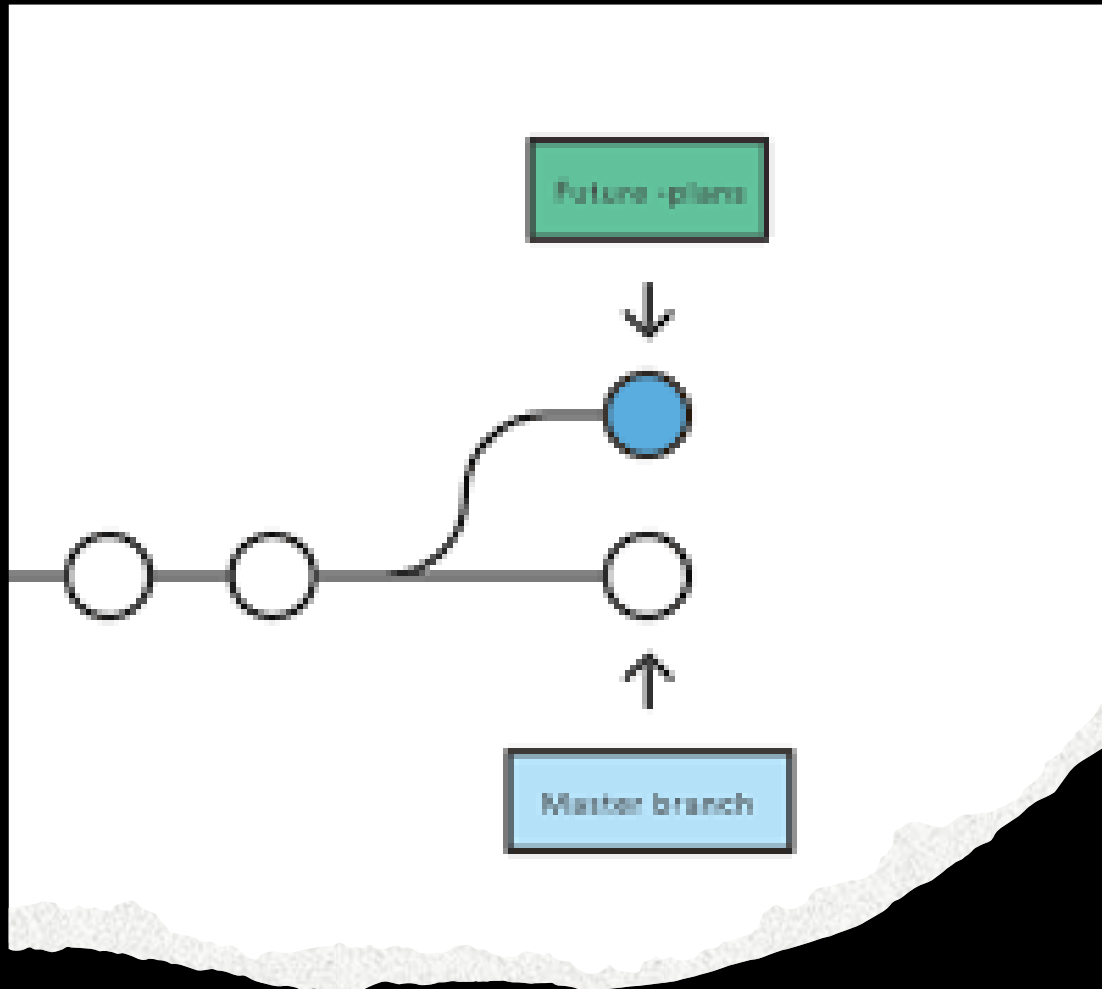

# OTRO TIPO

- Experimental Branch
- Future Branch
- Collaboration Branch
- Team Integration

# PULL REQUEST



Create Branch

Create Pull Request

Merge Branch

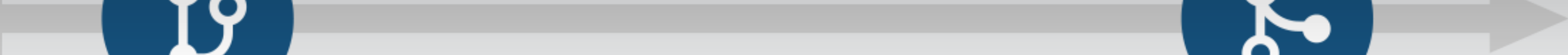



# PREGUNTAS